

MEMO

Thanks for buying the  Wouxun transceiver.

This transceiver offers latest design, enhanced features, solid performances and easy accessibility. We believe you will be pleased with the high quality and reliable features for all your communication needs.

READ THIS IMPORTANT INFORMATION ON THE SAFE AND EFFICIENT OPERATION BEFORE USING  PORTABLE TRANSCIEVER. This manual is ONLY suitable for KG-UV9D&KG-UV9D(E).

User Safety, Training, and General Information

READ THIS IMPORTANT INFORMATION ON SAFE AND EFFICIENT OPERATION BEFORE USING YOUR **Wouxun** PORTABLE TWO-WAY RADIO.

Compliance with RF Energy Exposure Standards

Your **Wouxun** two-way radio is designed and tested to comply with a number of national and international standards and guidelines (listed below) regarding human exposure to radio frequency electromagnetic energy. This radio complies with the IEEE (FCC) and ICNIRP exposure limits for occupational/controlled RF exposure environment at duty cycles of up to 50% talk-50% listen and should be used for occupational use only. In terms of measuring RF energy for compliance with the FCC exposure guidelines, your radio radiates measurable RF energy only while it is transmitting (during talking), not when it is receiving (listening) or in standby mode.

NOTE

» The approved batteries supplied with this radio are rated for a 5-5-90 duty cycle (5% talk-5% listen-90% standby), even though this radio complies with the FCC occupational RF exposure limits at duty cycles of up to 50% talk.

Your **Wouxun** two-way radio Complies with the following of RF energy exposure standards and guidelines:

- United States Federal Communications Commission, Code of Federal Regulations; 47CFR part 2 sub-part J
- American National Standards Institute (ANSI)/Institute of Electrical and Electronic Engineers (IEEE) C95. 1-1992
- Institute of Electrical and Electronic Engineers (IEEE) C95. 1-1999 Edition
- International Commission on Non-Ionizing Radiation Protection (ICNIRP) 1998

Operational Instructions and Training Guidelines

To ensure optimal performance and compliance with the occupational/controlled environment RF energy exposure limits in the above standards and guidelines, users should transmit no more than 50% of the time and always adhere to the following procedures:



Transmit and Receive

To transmit (talk), push the Push-To-Talk (PTT) button; to receive, release the PTT button.





Hand-held radio operation

Hold the radio in a vertical position with the microphone 5 cm away from the lips and keep the antenna far away from your head.

Body-worn operation

Always place the radio in an  approved clip, holder, holster, case, or body harness for this product. Use of non- -approved accessories may exceed FCC RF exposure guidelines.

Antennas & Batteries

- Use only  approved, supplied antenna or  approved replacement antenna.
- Unauthorized antennas, modifications, or attachments could damage the radio and may violate FCC regulations.
- Use only  approved, supplied batteries or  approved replacement batteries.
- Use of non- -approved batteries may exceed FCC RF exposure guidelines.



Approved Accessories

For a list of  approved accessories, see the accessories page of this user manual or visit the following website which lists approved accessories: <http://www.wouxun.com>

Notices to the User

- Government law prohibits the operation of unlicensed radio transmitters within the territories under government control.
- Illegal operation is punishable by fine or imprisonment or both.
- Refer service to qualified technicians only.

Warning

- » It is important that the operator is aware of and understand hazards common to the operation of any transceiver. Explosive environment (such as gases, dust, fumes, etc). Turn off your transceiver while talking on fuel, or parking in gasoline service stations.
- » If you require this machine to be developed or get some changes, please contact with  or your  dealer.

FCC Caution:

This equipment has been tested and found to comply with the part 90 of the FCC Rules. These limits are designed to provide reasonable protection against harmful interference in a residential installation. This equipment generates, uses and can radiate radio frequency energy and, If the equipment is not installed and used in accordance with the instructions, it may cause harmful interference to radio communication. However, there is no guarantee that interference will not occur in a particular installation. If this equipment

does cause harmful interference to radio or television reception, which can be determined by turning the equipment off and on, the user is encouraged to try to correct the interference by one or more of the following.

Measures:

- Reorient or relocate the receiving antenna.
- Increase the separation between the equipment and receiver.
- Connect the equipment into an outlet on a circuit different from that to which the receiver is connected.
- Consult the dealer or an experienced radio/TV technician for help.

FCC Licensing Requirements

Your radio must be properly licensed Federal Communications Commission prior to use. Your  Wireless dealer can assist you in meeting these requirements. Your dealer will program each radio with your authorized frequencies, signaling codes, etc., and will be there to meet your communications needs as your system expands.

Precautions

Only qualified technicians are allowed to maintain this product.

Do not use the radio or charge a battery in explosive areas such as coal gas, dust, steam, etc.

Switch OFF the radio while refueling or parking at a gas station.

Do not modify or adjust this radio without permission.

Do not expose the radio to direct sunlight over a long time, nor place it close to heat source.

Do not place the radio in excessively dusty, humid areas, nor place close to heating appliances.

Safety: It is important that the operator is aware of and understands hazards common to the operation of any radio.

This device complies with Part 15 of the FCC Rules.

Operation is subject to the following two conditions:

- (1) this device may not cause harmful interference, and
- (2) this device must accept any interference received, including interference that may cause undesired operation.

Warning

» MODIFICATION OF THIS DEVICE TO RECEIVE CELLULAR RADIOTELEPHONE SERVICE SIGNALS IS PROHIBITED UNDER FCC RULES AND FEDERAL LAW.

CE Caution:

Hereby, **Wouxun** declares that this Two-way radio is in compliance with the essential requirements and other relevant provisions of Directive 1999/5/EC.

A copy of the DOC may be obtained through the following address.

Address: No.928 Nanhuan Road, Jiangnan High Technology Industry Park, Quanzhou, Fujian 362000,
China

Contents



Professional FM Transceiver

Unpacking and checking the equipment	01
Installing before use	02
Getting Started	03-08
<i>Description of Features</i>	<i>03-04</i>
<i>Specifications</i>	<i>05</i>
<i>Description of Transceiver</i>	<i>06-08</i>
Basic Operation	09-13
Shortcut Operation Sheet	14-21
How to Operate	22-44
<i>Auto Brightness Time (ABR) ----- MENU1</i>	<i>22</i>
<i>Save Power Mode (SAVE) ----- MENU2</i>	<i>22</i>
<i>Step Frequency (STEP) ----- MENU3</i>	<i>22</i>
<i>Bandwidth Selection (W/N) ----- MENU4</i>	<i>23</i>
<i>Transmitting Power Selection (TXP) ----- MENU5</i>	<i>23</i>
<i>Frequency Shift Direction (SFT-D) ----- MENU6</i>	<i>23</i>
<i>VOX (VOX) ----- MENU7</i>	<i>24</i>
<i>Squelch Level (SQL-LE) ----- MENU8</i>	<i>24-25</i>
<i>Roger (ROGER) ----- MENU 9</i>	<i>25</i>

Contents

<i>Transmitting Out Timer (TOT)</i> ----- MENU10	25
<i>Transmitting Overtime Alarm (TOA)</i> ----- MENU11	26
<i>Voice Switch (VOICE-SW)</i> ----- MENU12	26
<i>Beep Prompt (BEEP)</i> ----- MENU13	26
<i>Menu Language (MENULANGE)</i> ----- MENU14	26-27
<i>Busy Channel Lockout (BCL)</i> ----- MENU15	27
<i>Receiving CTCSS (RX-CTC)</i> ----- MENU16	27
<i>Transmitting CTCSS (TX-CTC)</i> ----- MENU17	27
<i>Receiving DCS (RX-DCS)</i> ----- MENU18	28
<i>Transmitting DCS (TX-DCS)</i> ----- MENU19	28
<i>Scan Mode (SC-REV)</i> ----- MENU20	28
<i>Mute Mode (SP-MUTE)</i> ----- MENU21	29
<i>DTMF Sidetone (DTMF-ST)</i> ----- MENU22	29
<i>PTT ID (PTT-ID)</i> ----- MENU23	29-30
<i>ANI ID Code Edit (ID-EDIT)</i> ----- MENU24	30
<i>Transmitting ANI ID Code Delay (ID-DLY)</i> ----- MENU 25	30
<i>Ring Time (RING)</i> ----- MENU26	31
<i>Back Light Brightness Level (ABR-LV)</i> ----- MENU27	31

<i>Offset Frequency (OFFSET)</i> ----- MENU28	31
<i>Channel Name Edit (CH-NAME)</i> ----- MENU29	31-32
<i>Memory Channel (MEM-CH)</i> ----- MENU30	32
<i>Delete Channel (DEL-CH)</i> ----- MENU31	32-33
<i>Priority Channel (PRI-CH)</i> ----- MENU32	33
<i>Priority Scanning (PRI-SCN)</i> ----- MENU33	33
<i>Keypad Auto Lock (AUTOLOCK)</i> ----- MENU34	34
<i>Lock Mode (LOCKMODE)</i> ----- MENU35	34
<i>Single Tone Setting (S-TONE)</i> ----- MENU36	34-35
<i>VOX Delay (VOX-DLY)</i> ----- MENU37	35
<i>Save CTCSS/DCS Mode (SC-QT)</i> ----- MENU38	35
<i>Auto Power-off Timer (APO-TMR)</i> ----- MENU39	35
<i>Power on Message (PONMSG)</i> ----- MENU40	36
<i>Backlight Switch(BLCDSW)</i> -----MENU41	36
<i>Indicator Switch(BLEDSW)</i> -----MENU42	36
<i>Repeat Setting (TYPE-SET)</i> -----MENU43	36-37
<i>Repeat Speaker(RPT-SPK)</i> -----MENU44	37
<i>Repeat PTT(RPT-PTT)</i> -----MENU45	37

<i>Repeat Hold Time (RPT-KPT) -----MENU46</i>	37-39
<i>Repeater Receipt Tone (RPT-RCT) ----- MENU47</i>	39
<i>Scan Adding (SCN-ADD) ----- MENU48</i>	39
<i>Scan Channel Group (SCN-GP) ----- MENU49</i>	40
<i>Scan Mode (SCN-MODE) ----- MENU50</i>	40
<i>Scan CTCSS/DCS (SCN-CD) ----- MENU51</i>	41
<i>Caller ID (CALL ID) ----- MENU52</i>	41-42
<i>Auto Distinguish AM Mode (AUTO-AM) ----- MENU53</i>	42
<i>AM Switch (AM-SW) ----- MENU54</i>	42
<i>PFI Definition (PFI-DEF) ----- MENU55</i>	43
<i>PF2 Definition (PF2-DEF) ----- MENU56</i>	44
<i>PF3 Definition (PF3-DEF) ----- MENU57</i>	44
<i>Voltage Check (VOLTAGE) ----- MENU58</i>	44
<i>QT Detection (QT-SW) ----- MENU59</i>	44
<i>Sub Band Mute (S-MUTE) ----- MENU60</i>	45
<i>Reset (RESET) ----- MENU61</i>	45
<i>Detailed Instructions of Some Important Functions</i>	46-53
<i>Specification (CTCSS/DCS)</i>	54-55

<i>Trouble Shooting</i>	56-57
<i>Optional Accessories</i>	58
<i>Announcement</i>	59

Batterypack Working Time

Before taking the radio outside, it is necessary to learn how long the batterypack can work. The following table for working time is based on the test of the below circle conditions:

Transmission for 6 seconds Receiving for 6 seconds Standby for 48seconds

Batterypack	Output Power	Estimated Working Time(Hour)
Standard 2000mah	High Power	8
	Middle Power	12
	Low Power	14

Working Time in Standby Test:

Condition: a.Standard 2000mAH batterypack, b.In Power Save Mode,c.No transmission or receiving,
No-working Backlight.

Working Time in Standby: Continuous 38 hours.

Unpacking and checking the equipment

Carefully unpack the transceiver. We recommend that you identify the items in the following table before discarding the packing material. If any item is missed or has been damaged during shipment, please notify your **Wouxun** dealer.

Supplied Accessories

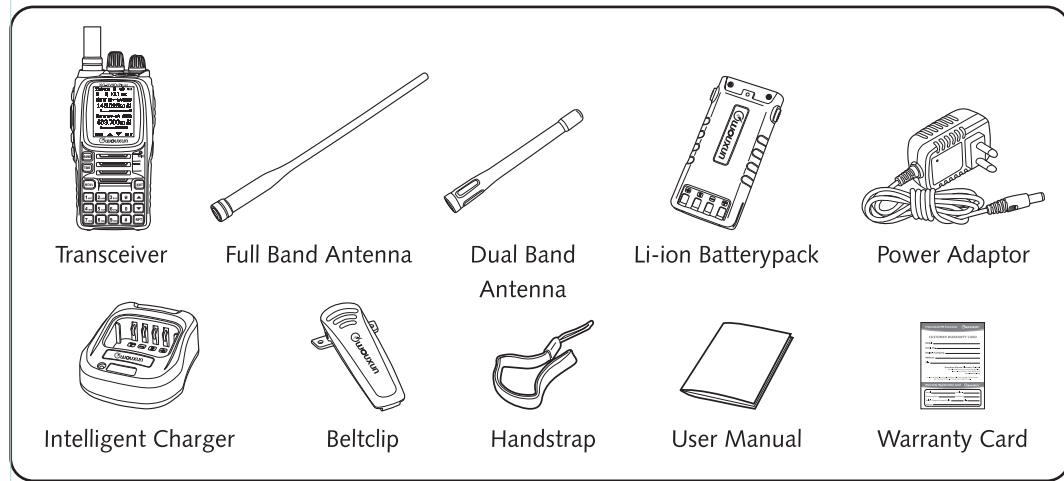

Installing before use

Install / remove battery pack

The battery pack is not fully charged before leaving factory. Please charge it before use.

NOTE

- » Do not shortcircuit the terminals or put the battery pack into fire.
- » Do not try to remove the case from the battery pack.

1. Please aim the battery pack at the back of the transceiver, and then push up and press down the battery pack to lock the release latch. (PIC1)
2. If you want to remove the battery pack, push down the release latch, and the battery pack will be released from the transceiver. (PIC2)

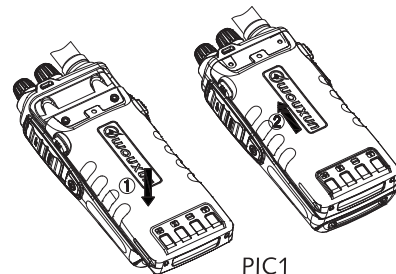

PIC1

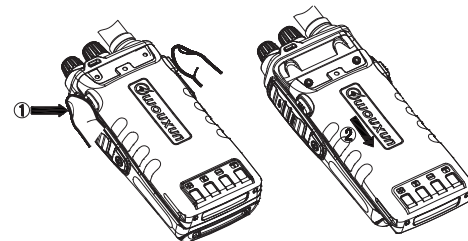

PIC2

Description of Features

1. Frequency Range(suitable for different countries or areas):

A Area	B Area
TX:136-174MHz(FM)	TX:136-174MHz(FM)
400-512MHz(FM)	400-512MHz(FM)
RX:108-136MHz(AM Band Receiving)	RX:136-174MHz(FM)
136-180MHz(FM)	400-512MHz(FM)
230-250MHz(FM)	76-108MHz(FM Radio)
350-400MHz(FM)	
400-512MHz(FM)	
700-985MHz(FM)	
2. Twin Band Simultaneous Receiving(U-U,U-V,V-U,V-V)
3. Separate Bands Duplex(U-V,V-U)
4. DTMF Encoding/Decoding
5. All Calls, Group Calls and Selective Calls
6. Stun,Kill,Monitor and Inspection
7. CTCSS/DCS Scan
8. Programmable Non-Standard CTCSS/DCS
9. Multi Scan Modes:Programmable Scanned Frequency Range(only available in Frequency Mode);

- Channel Groups Scan(only available in Channel Mode)
10. VOX
11. Multi Functions Programmable for Side Keys, Programmable Transmission Function on Sub-Frequency (Side Key Function Programmable)
12. English Voice Guide
13. Priority Scan, Priority Channel Setting
14. Twin Band Simultaneous Scan
15. Multi Power Save Modes
16. Auto Power-Off Timer(APO)
17. Three Output Power Levels:
UHF:H:4W, M:2W, L:1W
VHF:H:5W, M:2W, L:1W
18. Multi Single-Tone Pulse
(1750Hz,2100Hz,1000Hz,1450Hz)
19. Multi Keypad Lock Modes
20. PTT ID
21. Wide/Narrow Bandwidth Selection
22. Backlight Brightness Selection
23. Cross-Band Repeat function

Specifications

Intergration		Receiving	Wide bandwidth	Narrow bandwidth	
Frequency Range	A Area TX:136-174MHz(FM) & 400-512MHz(FM) RX:108-136MHz(AM Band Receiving) 136-180MHz(FM) 230-250MHz(FM) 350-400MHz(FM) 400-512MHz(FM) 700-985MHz(FM)	Adjacent Channel Selectivity	≤ 70dB	≤ 60dB	
	B Area TX:136-174MHz(FM) & 400-512MHz(FM) RX:136-174MHz(FM) 400-512MHz(FM) 76-108MHz(FM Radio)	Inter Modulation	≤ 65dB	≤ 60dB	
		Spurious Response	≤ 70dB	≤ 70dB	
		Audio Response	+1~3dB (0.3~3KHz)	+1~3dB(0.3 ~2.55KHz)	
Step	2.5KHz / 5KHz / 6.25KHz / 10KHz / 12.5KHz / 25KHz / 50KHz / 100KHz	Signal to Noise Ratio	≥ 45dB	≥ 40dB	
Channel Number	999	Audio Distortion	≤ 5%		
Work Mode	F2D / F3E	Audio Power	Transceiver ≤ 500mW		
Operating Temperature	-20℃ or 40℃	Sensitivity	108-136MHz(AM)-106dBm SINAD 13db		
Antenna Resistance	50Ω		136-180MHz(AM)-119dBm SINAD 13db		
Voltage	7.4VDC		230-250MHz(AM)-116dBm SINAD 13db		
Weight	490g		350-400MHz(AM)-119dBm SINAD 12db		
Size	124.5x 61.49 x 33.88 (mm)		400-512MHz(AM)-119dBm SINAD 13db		
			700-985MHz(AM)-96dBm SINAD 13db		
Transmitter	Wide bandwidth	Narrow bandwidth	Transmitter	Wide bandwidth	Narrow bandwidth
Type of Modulation	16K F3E	11K F3E	Max Frequency Deviation	± 5KHz	± 2.5KHz
Adjacent Channel Power	≥ 70dB	≥ 60dB	Frequency Stability	± 2.5ppm	
Spurious	≥ 60dB	≥ 60dB	Audio Distortion	≤ 5%	
Audio Response	+1~3dB (0.3~3KHz)	+1~3dB (0.3~2.55KHz)	Output Power	UHF H:4W,M:2W,L:1W	VHF H:5W,M:2W,L:1W

Note: 2.5K step is only available on KG-UV9D(E) version.

Description of Transceiver

LCD Screen

There are various indicators display on the screen when powering on. Please refer the below table to learn what the indicators stand for accordingly.

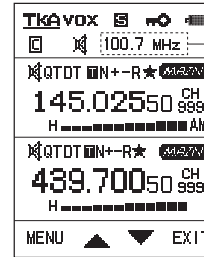

- Function Display
- Personal Message or FM Radio Frequency Display
- Channel NO. on A area, or Frequency Display
- Channel NO. on B area, or Frequency Display
- Operation Indication

TKA : Talk Around

VOX : VOX

S : Power Save Activated

B : Batterypack Voltage Display

P : Priority Function Activated

M : Mute Function Activated

QT : CTCSS Activated

DT : DCS Activated

T : DTMF Encoding/Decoding

N : Narrow Bandwidth **W** : Wide Bandwidth

+ : Positive Offset **-** : Negative Frequency

----- : Output Power or Receiving Signal Meter Indicator

R : Reverse Frequency

★ : Current Channel is Priority

M-FREQ : Main Frequency

CH 999 : Current Channel NO.

AM : AM Modulation

H_ML : Output Power Level

Getting Started

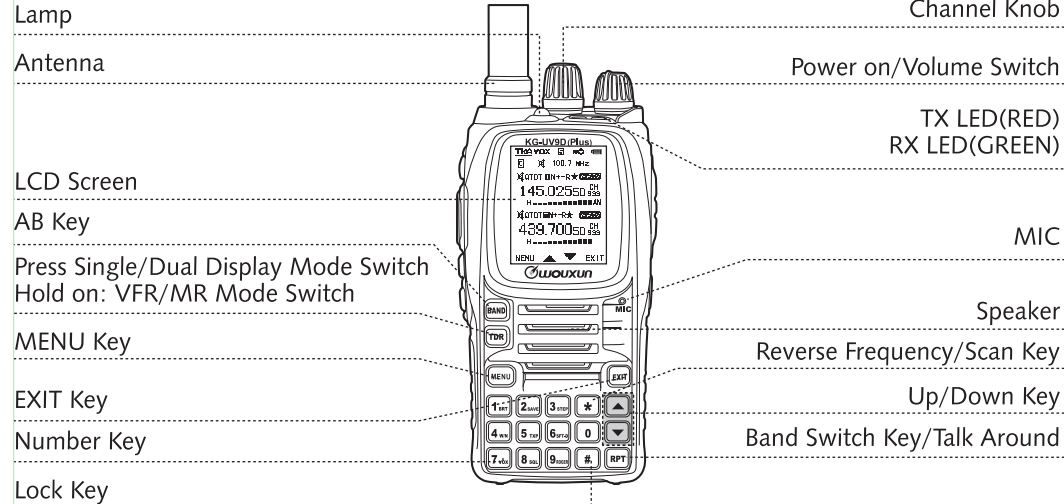

Sidekey PF1: No Function, Selective Calls, Distant Alarm SOS, TX on Sub-frequency

PTT Key

Sidekey PF2:
 Short Press:
 Enter/Exit FM Radio
 Hold On (for 1s)
 Scan/Stopwatch/Lamp/
 Frequency Shift/Frequency
 Direction/Keypad Light

Sidekey PF3:
 Short Press:
 Squelch (MONI Key)
 Hold On:
 No Function, Selective Calls, Distant Alarm SOS, TX on Sub-Frequency

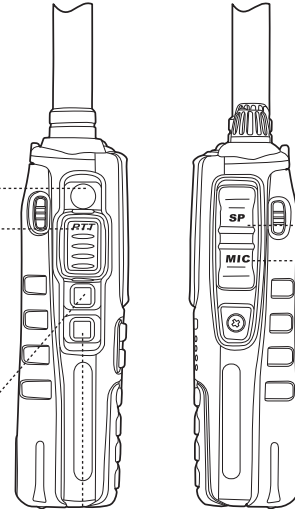

Earphone Jacket

(1) Main Frequency Switch

Press **BAND** to select the main frequency. The frequency with **MAIN** at the left top corner of the screen is the main frequency ; the frequency without **MAIN** is the sub-frequency.

(2) Sub-Frequency Transmission Key

PTT key is for transmission on main frequency. If you want to transmit on sub-frequency, please change main frequency or program PF1 or PF3 as sub-frequency transmission.

When programming PF1 or PF3 as sub-transmission function, please press PF1 or PF3 directly to transmit without changing the main frequency.

■ Program PF1 as sub-frequency transmission

Program PF1 via MENU49 as sub-frequency transmission function when holding on.

■ Program PF3 as sub-frequency transmission

Program PF3 via MENU51 as sub-frequency transmission function when holding on.

(3) Speed Search

Press UP/DOWN key to select your desired function or parameter.

(4) # key

In FM radio mode, press **#** to program FM radio frequency. Hold on **#** for 1 second to lock or unlock the keypad.

(5) * key

Press ***** to activate or turn off the reverse function. Hold on ***** for 2 seconds to activate the scan function.

(6) RPT key

In standby, press RPT key to switch the main frequency. Hold on RPT key to activate talk around function.

(7) TDR key

Functions for pressing **TDR** key: Single Band/Dual Band Display Switch.

Press **TDR** key each time, the sub frequency will be turned off or on to carry Single Band/Dual Band display switch.

Functions for holding on **TDR** key: Work Mode(VFO/MR) Switch
Switch Work Modes(VFO/MR) is as followings:

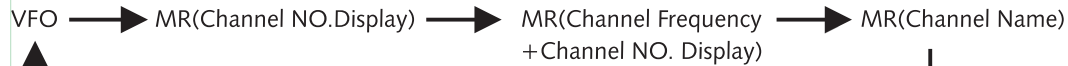

If setting work mode switch password, press **TDR**, the LCD screen displays , please input the 6 characters passwords. Please set work mode switch passwords via *wouxun* supplied programming software. When the work mode switch passwords are made up of full "0", you do not need to input password when switching work mode.

(8) DTMF Encoding

In transmission mode, directly press the number keys or function keys to transmit the corresponding DTMF codes. The keys and the DTMF encoding codes are corresponding as following:

				EXIT
1 BRT	2 SAVE	3 STEP	*	▲
4 WNR	5 TXP	6 SFT-L	0	▼
7 VOX	8 SOL	9 RIDER	#	RPT

➔

				A
1	2	3	*	B
4	5	6	0	C
7	8	9	#	D

(9) Wireclone Function

Purpose: Cloning all parameters(including channel parameters) of the source transceiver to the target transceiver.

- Steps:
- Taking two transceivers, one is as the source transceiver, the other one is as the target transceiver.
 - Using wireclone cable to connect the source transceiver (Power-Off Mode) and the target transceiver (Power-On Mode).
 - Holding on PF3 to power on the transceiver simultaneously.

Status: Red LED of the source transceiver flashes, the LCD screen displays "M:COPY COMM"; red LED of the target transceiver flashes, the LCD screen displays "S:COPYING". After successfully wire cloning, the LCD screens of the source and target transceivers display "COPY END", and then the transceiver restart automatically. If the clone is failed, the source transceiver display "COPY FAIL". And then the transceivers restart automatically without notice.

(10) How to use the intelligent charger

When the battery power is low, the transceiver will activate voice guide, and prompt "Di" in every 5 seconds.

- Insert the AC plug into outlet (AC:90-240V), the charger indicator flashes once. That means the

Basic Operation

charging is in standby.



2. Insert the battery into the charger, the RED indicator continuously flashes. That means the charging is on the progress.

While the GREEN indicator continuously flashes. That means the charging is completed.

NOTE

- » When inserting the exhausted battery into the charger, it will pre-charge the battery in trickling mode, the RED light of charger flashes and lasts 10-20 minutes, then start normal charger with RED light keeping on, it will turn to GREEN when it is fully charged.
- » Trickle charge the exhausted battery is to protect the lithium-ion battery.

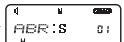
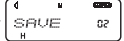
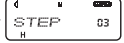
Shortcut Operation Sheet

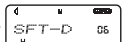
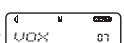
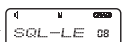
Function order	Function name	Enter function set	Screen display	Select parameter	Selectable parameter explanation	Confirm	Return to standby
1	Auto Backlight Time (ABR)	MENU → 1 _{ABR}		MENU → Press ▲ or ▼ key Select parameter	ALWAYS ON/OFF/1-30S	MENU	EXIT
2	Power Save Mode (SAVE)	MENU → 2 _{SAVE}		MENU → Press ▲ or ▼ key Select parameter	OFF/01-04	MENU	EXIT
3	Step Frequency (STEP)	MENU → 3 _{STEP}		MENU → Press ▲ or ▼ key Select parameter	8 frequency steps available: 2.5k/5k/6.25k/10k/12.5k/ 25k/50k/100k	MENU	EXIT
4	Bandwidth Selection (W/N)	MENU → 4 _{W/N}		MENU → Press ▲ or ▼ key Select parameter	WIDE: 25KHz NARR: 12.5KHz	MENU	EXIT
5	Transmitting Power Selection (TXP)	MENU → 5 _{TXP}		MENU → Press ▲ or ▼ key Select parameter	H: High power (VHF 5W/ UHF 4W) L: Low power (1W)	MENU	EXIT
6	Frequency Shift Direction (SFT-D)	MENU → 6 _{SFT-D}		MENU → Press ▲ or ▼ key Select parameter	+ Positive direction - Negative direction OFF: Turn off frequency shift direction	MENU	EXIT
7	VOX (VOX)	MENU → 7 _{VOX}		MENU → Press ▲ or ▼ key Select parameter	VOX has levels from 1 to 10 OFF: Turn off VOX transmission	MENU	EXIT
8	Squelch Level (SQL-LE)	MENU → 8 _{SQL}		MENU → Press ▲ or ▼ key Select parameter	Squelch level from 0 to 9	MENU	EXIT

Note: 2.5K step is only available on KG-UV9D(E) version.

Shortcut Operation Sheet

9 Begin/End Transmitting Prompt (ROGER)



Press ▲ or ▼ key
Select parameter

OFF: turn off this function, without any voice prompting.
BOT: press PTT, voice prompt when beginning transmitting
EOT: release PTT, voice prompt when ending transmitting
BOTH: press and release PTT, voice prompt



10 Time-out Timer

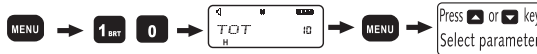

Press ▲ or ▼ key
Select parameter

TOT has 40 levels is steps of 15 seconds.
OFF: Turn off TOT



11 Transmitting Overtime Alarm

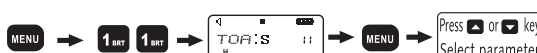

Press ▲ or ▼ key
Select parameter

OFF/01-10S



12 Voice Switch (VOICE-SW)

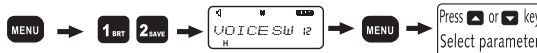

Press ▲ or ▼ key
Select parameter

ON: Activate
OFF: Deactivate



13 Beep Prompt



Press ▲ or ▼ key
Select parameter

ON: Turn on beep prompt function
OFF: Turn off beep prompt function



14 Menu Language



Press ▲ or ▼ key
Select parameter

ENGLISH



15 Busy Channel Lockout



Press ▲ or ▼ key
Select parameter

ON: Turn on BCL
OFF: Turn off BCL



16 Receiving CTCSS

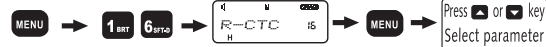

Press ▲ or ▼ key
Select parameter

50 groups CTCSS (67.0Hz-254.1Hz)
OFF: Turn off CTCSS
Non-Standard CTCSS Range: 62-260



17 Transmitting CTCSS



Press ▲ or ▼ key
Select parameter

50 groups CTCSS (67.0Hz-254.1Hz)
OFF: Turn off CTCSS
Non-Standard CTCSS Range: 62-260



18 Receiving DCS

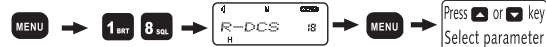

Press ▲ or ▼ key
Select parameter

105 groups DCS (D023N-D754I)
OFF: Turn off DCS
Non-Standard DCS Range: 0-777



19 Transmitting DCS

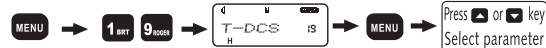

Press ▲ or ▼ key
Select parameter

105 groups DCS (D023N-D754I)
OFF: Turn off DCS
Non-Standard DCS Range: 0-777



20 Scan Mode

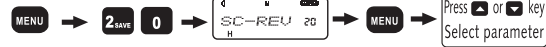

Press ▲ or ▼ key
Select parameter

3 Kinds of Scan modes
TO: Time scanning mode
CO: Carrier mode scan
SE: Search mode scan



21 Mute Settings

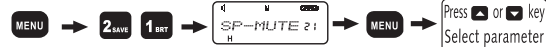

Press ▲ or ▼ key
Select parameter

There are three squelch settings: QT*T, QT, QT&T



Shortcut Operation Sheet

22 DTMF Sidetone Settings

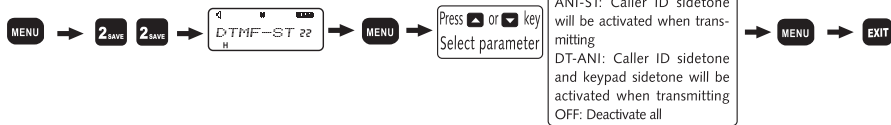

23 Caller ID Transmission Mode

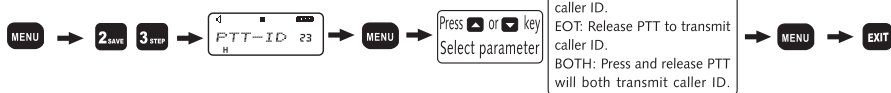

24 Editing Caller ID



25 Caller ID Transmission Delay



26 Ring Time



27 Backlight Selection



28 Offset Frequency



29 Channel Name Edit



30 Channel Memory



31 Channel Delete



32 Priority Channel



33 Priority Channel Scan



34 Keypad Auto Lock







34 Keypad Auto Lock



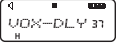
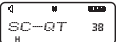
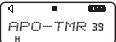

35 Keypad Lock Mode

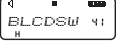
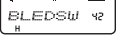

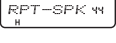
Shortcut Operation Sheet

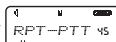
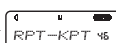
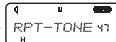
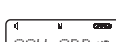
- 36 Single Tone (S-TONE) MENU → 3 STEP 6 SFT →  → MENU → Press ▲ or ▼ key Select parameter 1750Hz, 2100Hz, 1000Hz, 1450Hz → MENU → EXIT
- 37 VOX DELAY (VOX-DLY) MENU → 3 STEP 7 VOX →  → MENU → Press ▲ or ▼ key Select parameter OFF/01-05S → MENU → EXIT
- 38 Saving Scan Mode MENU → 3 STEP 8 SOL →  → MENU → Press ▲ or ▼ key Select parameter ALL: Save both RX and TX CTCSS/DCS
DEC: Save RX CTCSS/DCS
NEC: Save TX CTCSS/DCS → MENU → EXIT
- 39 Auto Power Off (APO-TMR) MENU → 3 STEP 9 ROER →  → MENU → Press ▲ or ▼ key Select parameter OFF/15-150Min → MENU → EXIT
- 40 Power On Message (PONMSG) MENU → 4 WIN 0 →  → MENU → Press ▲ or ▼ key Select parameter BITMAP: Picture
BATTY: battery Power → MENU → EXIT
- 41 Backlight Switch (BLCDSW) MENU → 4 WIN 1 BRT →  → MENU → Press ▲ or ▼ key Select parameter ON/OFF → MENU → EXIT
- 42 Indicator Switch (BLEDSW) MENU → 4 WIN 2 SAVE →  → MENU → Press ▲ or ▼ key Select parameter ON/OFF → MENU → EXIT
- 43 Repeat Setting (TYPE-SET) MENU → 4 WIN 3 STEP →  → MENU → Press ▲ or ▼ key Select parameter ON/OFF → MENU → EXIT
- 44 Repeat Speaker (RPT-SPK) MENU → 4 WIN 4 WIN →  → MENU → Press ▲ or ▼ key Select parameter ON/OFF → MENU → EXIT

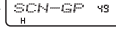
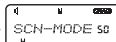
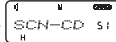
- 45 Repeat PTT(RPT-PTT) MENU → 4 WIN 5 TYP →  → MENU → Press ▲ or ▼ key Select parameter ON/OFF → MENU → EXIT
- 46 Repeat Hold Time (RPT-KPT) MENU → 4 WIN 6 SFT →  → MENU → Press ▲ or ▼ key Select parameter ON/OFF → MENU → EXIT
- 47 Repeater Receipt Tone (RPT-RCT) MENU → 4 WIN 7 VOX →  → MENU → Press ▲ or ▼ key Select parameter ON: Activate
OFF: Deactivate → MENU → EXIT
- 48 Scan Add (SCN-ADD) MENU → 4 WIN 8 SOL →  → MENU → Press ▲ or ▼ key Select parameter ON: When scanning channels, they will be added to the scanning table
OFF: Channels will not be added to the table when scanning → MENU → EXIT
- 49 Scan Channel Group NO. (SCN-GP) MENU → 4 WIN 9 ROER →  → MENU → Press ▲ or ▼ key Select parameter All: scan all
Group 1, Group 2, Group 3, Group 4, Group 5, Group 6, Group 7, Group 8, Group 9, Group 10 → MENU → EXIT
- 50 Scan Mode (SCN-MODE) MENU → 5 TYP 0 →  → MENU → Press ▲ or ▼ key Select parameter Current Band Scan/Full Bands
Scan/Limited FREQ BANGE SCAN → MENU → EXIT
- 51 CTCSS/DCS Scanning (SCN-CD) MENU → 5 TYP 1 BRT →  → MENU → Press ▲ or ▼ key Select parameter CTCSS/DCS → MENU → EXIT
- 52 Call Group ID (CALL-ID) MENU → 5 TYP 2 SAVE →  → MENU → Press ▲ or ▼ key Select parameter Groups:1-20 → MENU → EXIT

Shortcut Operation Sheet

53 Auto AM (AUTO-AM)	MENU → 5 TXP 3 STEP →		MENU →	Press ▲ or ▼ key Select parameter	ON: Activated OFF: Deactivated	→ MENU → EXIT
54 AM Switch (AM-SW)	MENU → 5 TXP 4 WRN →		MENU →	Press ▲ or ▼ key Select parameter	ON: Activated OFF: Deactivated	→ MENU → EXIT
55 PF1 Function Program	MENU → 5 TXP 5 TXP →		MENU →	Press ▲ or ▼ key Select parameter	SOS/SF-TX/OFF/CALL ID/ R-ALRM	→ MENU → EXIT
56 PF2 Function Program	MENU → 5 TXP 6 SFT4 →		MENU →	Press ▲ or ▼ key Select parameter	K-LAMP/OFF/SCN/SECOND /LAMP/SDF-DIR	→ MENU → EXIT
57 PF3 Function Program	MENU → 5 TXP 7 VOX →		MENU →	Press ▲ or ▼ key Select parameter	R-ALARM/SOS/SF-TX OFF/CALL ID	→ MENU → EXIT
58 Voltage Check	MENU → 5 TXP 8 SOL →		MENU →	Press ▲ or ▼ key Select parameter	Display Current Voltage	→ MENU → EXIT
59 CTCSS/DCS Scan Determine Switch	MENU → 5 TXP 9 ROSE →		MENU →	Press ▲ or ▼ key Select parameter	ON: Activated OFF: Deactivated	→ MENU → EXIT
60 Sub-Frequency Mute	MENU → 6 SFT4 0 →		MENU →	Press ▲ or ▼ key Select parameter	OFF/RX-MUTE/TX-MUTE/ R/T-Mute	→ MENU → EXIT
61 Reset Setting	MENU → 6 SFT4 1 BRT →		MENU →	Press ▲ or ▼ key Select parameter	VFO/ALL	→ MENU → EXIT

How to Operate

Auto Backlight Time (ABR) ----- MENU 1

Feature Description: This function is to set the time of activating LCD screen light.

Options: ALWAYS/OFF/1-30S, each level 1 second

Default: 8S

Power Save Mode (SAVE) ----- MENU 2

Feature Description: This function is to activate or deactivate the power save mode.

There are 4 modes.

Options: OFF/01/02/03/04(It is allowed to change the sleeping time)

Default: 01

Step (STEP) ----- MENU 3

Feature Description: This function is to select the desired step value.

Options: 2.5K/5K/6.25K/10K/12.5/20K/25K/30K/50K/100K

Default: 5K

NOTE

» 2.5K Step is only available on KG-UV9D(E) Version.

Bandwidth ----- Menu 4

Feature Description: This transceiver can work in wide bandwidth FM(± 25K) or narrow bandwidth FM (± 12.5K)

Selection : Wide / Narrow

Default : Wide

Transmit Power Selection ----- Menu 5

Feature Description: This function is to select the output power level

Selection : High / Middle / Low

UHF H : 4W , M : 2W , L : 1W

VHF H : 5W , M : 2W , L : 1W

Default : High

Frequency Shift Direction ----- Menu 6

Feature Description: This function is to set the transmission frequency is higher (+) or lower (-) than the reception frequency

Selection : Off / + / -

Default : Off

VOX ----- Menu 7

Feature Description: It is not necessary to press the PTT key manually every time after activating this function. Once the VOX circuit detect the microphone when you speak to, it may automatically enter the transmitting state.

Please select the VOX gain before using, the higher the gain, the greater the voice you may so that can be detected by VOX circuit and then enter the transmitting state. In order to ensure the continuity of VOX detection, you can also set up menu 37 "VOX delay". Details see the VOX delay on P33

Option: off /1-5 seconds

Default : Off

NOTE

- » VOX function is usable for the main frequency
- » On FM or receiving state, VOX detect is off.

Squelch Level ----- Menu 8

Feature Description: This function to make the speaker mute when there is no signal. If the squelch level setting is correct, it is only heard the sound truly receives the signal. The higher level the squelch requires the stronger signal.

Selection : 0-9 level

Default : 5

ROGER ----- Menu 9

Feature Description: The beep prompt after transmitting and end of transmitting.

Selection: Off / BOT / EOT /BOTH

Default: Off

BOT (beep after pressing PTT) EOT(beep after loosening PTT) BOTH(beep after pressing and loosening PTT)

Time out timer ----- Menu 10

Feature Description: Time out timer refers to set the limited time each transmitting, it may automatically stop transmitting if reach the limited time, regardless you press the PTT, the transceiver may issued the "time out timer" at the same time.

Selection : 15-600 seconds, step 15 seconds

Default : 60 seconds

NOTE

» There is a 10-second TOT punishment when the transmitting time beyond the limited time , it is invalid to press the PTT. The TOT punishment is effective for the keypad transmission and VOX transmission.

Time of Alarm ----- Menu 11

Feature Description: Time of alarm is to alarm that the transceiver is reaching the limited transmission time, and the indication light may flashing.

Selection : Off / 1-10 seconds, step 1 second.

Default : 5 seconds

Voice Switch ----- Menu 12

Feature Description: To open or close the menu operating prompt.

Selection : On / Off

Default : On

Beep ----- Menu 13

Feature Description: Beep is an indication for checking the transceiver operation prompt, operation error or fault.

Selection : On / Off

Default : On

Menu Language (MENULANGE) ----- MENU 14

Feature Description: This function is to activate English on menu display and voice guide.

Option:English

Default:English

Busy Channel Lockout (BCL) ----- MENU15

Feature Description: If the selected channel or frequency is occupied by the other transceivers, when you press PTT key to transmit after activating this function, the transceiver will not transmit, in order to avoid the conflict with the other communicating transceivers.

Option:ON/OFF

Default:OFF

Receiving CTCSS (Rx-CTC) ----- MENU 16

Feature Description: This function is to select receive CTCSS value.

Option:OFF/50 Groups Standard CTCSS/Non-Standard CTCSS(62.0-260Hz)

Default:OFF

Transmitting CTCSS (Tx-CTC) ----- MENU 17

Feature Description: This function is to select transmitting CTCSS value.

Option:OFF/50 Groups Standard CTCSS/Non-Standard CTCSS(62.0-260Hz)

Default:OFF

Receiving DCS (Rx-DCS) ----- MENU 18

Feature Description: This function is to select receiving DCS.

Option:OFF/105 Groups Standard DCS/ Non-Standard DCS(000-777)

Default:OFF

Transmitting DCS (Tx-DCS) ----- MENU 19

Feature Description: This function is to select transmitting DCS.

Option:OFF/105 Groups Standard DCS/ Non-Standard DCS(000-777)

Default:OFF

Scan Mode (SC-REV) ----- MENU 20

Feature Description: This function is to select the scan modes.

Option:TO/CO/SE

Default:SE

TO: after finding a carrier wave signal, scanning will continue if no operations are carrier out within 5 seconds.

CO: scanning will stop when a carrier wave signal has been found, and scanning will continue if the carrier wave signal is lost for 3 seconds.

SE: scanning will stop when a carrier wave signal is found.

Mute Mode (SP-MUTE) ----- MENU 21

Feature Description: This function is to set the mute mode to activate the speaker in receiving mode.

Option:QT/QT*T/QT&T

QT: When the transceiver is set to this mode, all signals on the same QT frequency will activate the speaker.

QT&T: only those signals which both satisfy the requirements of QT and whose DTMF carrier wave signal also match the transceiver will activate the speaker in this mode.

QT*T: When this mode is active, only those signals which either meet QT requirements or DTMF requirements will activate the speaker.

DTMF Sidetone (DTMF-ST) ----- MENU 22

Feature Description: In transmission mode, the transceiver transmits ANI ID code or DTMF code, if the speaker can receive the DTMF tone.

Option:DT-ST/ANI-ST/DT+ANI/OFF

Default:DT-ST

Caller ID Transmission Mode (PTT-ID) ----- MENU 23

Feature Description: This function is to select the caller ID transmission mode.

Option:OFF/BOT/EOT/BOTH

Default:OFF

BOT:Transmitting caller ID when pressing PTT key.

EOT:Transmitting caller ID when releasing PTT key.

BOTH:Transmitting caller ID when pressing or releasing PTT key.

Caller ID Edit (ID-EDIT) ----- MENU 24

Feature Description: This function is to edit caller ID of the transceiver.

Option:Numerals(0-9)

Default:101

Editing Methods:a. Via supplied  programming software b. Via Keypad

Caller ID Transmission Delay (ID-DLY) ----- MENU 25

Feature Description: The time distance between pressing PTT key and starting to transmit caller ID.

Option:100-3000ms, each 100ms per level.

Default:300ms

Attention

» The lasting time of transmitting DTMF and the transmitting delay time between two DTMF codes can be programmed via  Supplied programming software.

Ringing Time (RING) ----- MENU 26

Feature Description: The lasting time for ringing before speaking when receiving the signals.

Option: OFF/1-10s, each 1s per level.

Default: 3s

Backlight Brightness (BAR-LV) ----- MENU 27

Feature Description: This function is to select the brightness of backlight.

Option: 1-5(Level)

Default: 3(Level)

Offset Setting (OFFSET) ----- MENU28

Feature Description: Setting on the Frequency Offset.

Option: 000.00000-999.9975MHz

Default: 000.00000MHz

Channel Name (CH-NAME) ----- MENU29

Feature Description: Name Editing for memory channels.

Input the numbers, then the cursor automatically moves to the next position. Press ▲ / ▼ to switch the characters, while press # to confirm. Press EXIT to delete the editing content while long press EXIT to

exit from the operation.

Option: 26 Capital and Lower-case Letters, 0-9 Arabic Numbers and Special Characters.

Default: None

Editing: Editable via programming software or through the keypad manually.

Editing through the keypad

In standby(Channel Mode), press **MENU** **2** **SAVE** **9** **RESET** **MENU** to start the channel name editing. Input the desired Arabic numbers through the keypad or press ▲ / ▼ to display and get the characters and numbers.

Press # to confirm.

E.g: Press ▲ twice to get "!" and then press # to confirm and move forward to the next position editing. (Not needed to press # to confirm the numbers input.

Memory Channels (MEM-CH) ----- MENU30

Feature Description: Save the desired frequencies and parameter into the specified channels.

Option: 999 memory channels

Default: CH-001

Deleting Channels (DEL-CH) ----- MENU31

Feature Description: Delete the saved channels which you do not want to use.

Option: 999 memory channels

Default: CH-001

Priority Channels (PRI-CH) ----- MENU32

Feature Description: Choose and set the programming channels priority which you use often

Option: 999 memory channels

Default: CH-001

Priority Scan (PRI-SCN) ----- MENU33

Feature Description: Switch for turning ON or OFF to scan the priority channels. When ON, it will monitor the priority channels every three seconds in the main area. If received the carrier on the priority channel, it will be automatically switched to be the receiving channel.

Option: ON / OFF

Default: OFF

NOTE

» When powering on, there will be a three-second interrupt for receiving on the main area because of the monitoring on the priority channels.

Auto Lock (AUTOLOCK) ----- MENU34

Feature Description: When powering on, the keypad will be automatically locked if there are no more operations for 15 seconds on the keyboard.

Option: ON / OFF

Default: OFF

Lock Mode (LOCKMODE) ----- MENU35

Feature Description: Settings about locking the radios in different modes.

Option: Lock the keyboard, lock the keyboard and the encoders, lock the keyboard and PTT, lock the all.

Default: Lock the keyboard

Tips

Lock the keyboard, it locks the keypad including the side keys PF1, PF2 and PF3

Lock the keyboard, it locks the keypad and encoders including the side keys PF1, PF2 and PF3.

Lock the keyboard, it locks the keypad and PTT including the side keys PF1, PF2 and PF3.

Lock the all, it locks the above all options.

Single Tone Setting (S-Tone) ----- MENU36

Feature Description: It transmit the required single plus frequencies mainly used for activating the repeater.

Option: 1000Hz/ 1450Hz/ 1750Hz/ 2100Hz

Default: 1750Hz

VOX Delay (VOX-DLY) ----- MENU37

Feature Description: It is the delay time setting for turning off PTT after the VOX transmitting.

Option: OFF, 1 to 5 seconds

Default: 1 second

QT Save (SC-QT) ----- MENU38

Feature Description: It is the save modes for the detected CTCSS/DCS tones in the frequency mode.

Option: RX QT, TX QT, RX/TX QT

Default: RX QT

Auto Power-Off Timer (APO-TMR) ----- MENU39

Feature Description: The transceiver will automatically power off if there are not any receiving or other operations within the preset time, in order to save the battery voltage..

Option: ON/OFF

Default: OFF

Power-ON Message (PONMSG) ----- MENE40

Feature Description: It is programmable to set the message display when power on.

Option: Battery Voltage, Brand Logo

Default: Brand Logo

Backlight Switch(BLCDSW) ----- MENE41

Function: Switch for backlight in standby

Option: ON/FF

Default: ON

Indicator Switch(BLEDSW) ----- MENE42

Function: Receiving Indicator flashes green every five seconds in standby

Option: ON/FF

Default: ON

Repeat Setting (TYPE-SET) ----- MENE43

Function: Work mode for Repeat Setting

Option: Walkie Talkie(TALKIE), Directional Cross-Band Repeat(DIR-RPT),

Two-way Cross-Band Repeat(TW-RPT)

Default: Transceiver

Repeat Speaker(RPT-SPK) ----- MENE44

Function: Whether turning on the speaker for Repeat Setting

Option:ON/FF

Default: ON

Repeat PTT(RPT-PTT) ----- MENE45

Function: Whether PTT being activated for Repeat Setting

Repeat Hold Time(RPT-KPT) ----- MENE46

Function: Setting the hold time for Repeating operations

Option: OFF/ 100-500ms selectableDefault: 300ms

Repeat Setting

It is required the two working channels are two different frequencies of bands, i.e., it is UHF frequency in A area while it should be VHF frequency in B area.

Directional Cross-Band Repeat(X-DIRPT)

It is repeating receiver which is only for receiving in main area while it is repeating transmitter which is only for transmitting in sub area.

Two-way Cross-Band Repeat(X-TWRPT)

In Standby, it is repeating receiver in both main and sub areas. After it receives carrier in main area, it switches to repeating transmitter in sub area. While it receives carries in sub area, then it switches to repeating transmitter in main area.

Repeat PTT

It is set to select whether using PTT to transmit out when repeating. The repeating signal is interrupted for a while PTT transmits.

Repeat Hold Time

When the signal disappears from the receiver, the user continues transmitting for a while when waiting for response within the valid hold time. If there is no more signal detected, it stops transmitting within the valid hold time.

For example

X-DIRPT

It is 150MHz in main A area, it is 430MHz in sub B area. When it receives signal(it is impossible to receive signal in sub B area during X-DIRPT mode), it transmit out 430MHz on sub B area.

X-TWRPT

It is 150MHz in main A area, it is 430MHz in sub B area. When it receives priority signal in A area, it transmit out 430MHz on sub B area. While it receives priority signal in B area, it transmit out 430MHz on sub A area. This is cross-band two-way repeat.

Repeating Reception (RPT-RCT) ----- MENU47

Feature Description: It is the reception confirmation when the receiving repeater is off during the transceiver is receiving the repeating signals.

Option: ON / OFF

Default: OFF

Scanning Channel Adding (SCN-ADD) ----- MENU48

Feature Description: Setting the programming channels to be on the list of the scanning channels.

Option: ON / OFF

Default: OFF

Scanning Groups (SCN-GP) ----- MENU49

Feature Description: It is available to get 10 groups memory for channels, and specified the desired one to the scanning channels.

Option: All, 1 to 10 groups

Default: All

Scanning Mode (SCN-MODE) ----- MENU50

Feature Description: The scanning range in VHF mode.

Three options as followings.

Scanning on the working band, it scans in the whole working range throughout the current frequency range.

Scanning on the limit range, it scans in a limited range which is programmable via the software ahead.

Scanning the whole six bands on this transceiver.

There are totally 7 bands on this transceiver, and six bands are included into the scanning list except the FM band 76-108MHz.

(1) 108-180MHz (4)350-400MHz

(2) 136-180MHz (5)400-512MHz

(3)230-250MHz (6)700-985MHz

Default: Scanning on the working band.

Scanning CTCSS/DCS (SCN-CD) ----- MENU51

Feature Description: Selection for CTCSS or DCS scanning.

Option: CTCSS Scanning, DCS Scanning

Default: CTCSS Scanning

NOTE

» The CTCSS/DCS is only workable in the receiving mode.

Please press  /  or rotate the encoder to change the scanning direction.

When detecting the CTCSS or DCS tone, the scanning stops on the tone. Press  to confirm and save it if needed.

Programmable this function via the programming software.

ID Groups (CALL-ID) ----- MENU52

Feature Description: Setting the groups for calling.

Option: 1 to 20 groups

Default: Group 1

NOTE

» Available to edit 3 to 6 digits from the Arabic numbers and "#".

» Only programmable via the software.

AM Detect (AUTO-AM) ----- MENU53

Feature Description: Automatically detect the AM frequencies. When powering on, the working mode of the frequencies within 108-136MHz will be automatically switched to AM.

Option: ON / OFF

NOTE

» This function is prior to MENU48(AM-SW) . When the AUTO-AM is ON, the frequencies within 108-136MHz will be switched to AM mode.

» Only workable on A area.

AM Switch (AM-SW) ----- MENU54

Feature Description: Set the receiving on AM mode. When powering on , the current frequencies will be AM receiving mode.

Option: ON / OFF

Default: OFF

Tips

(1) This function is only workable on A area.

(2) AM-SW will be automatically changed to OFF instead and the working mode will be switched to FM mode when the current frequencies or channels are changed.

Side key PF1 setting (PF1-DEF) ----- MENU55

Feature Description: Set the functions on side key PF1.

Option: None/ Selective Call/ Alarm/ SOS/ TX on the sub band(B-PTT)

Default: TX on the sub band(B-PTT)

NOTE

- » When the selective call is programmed onto this key, the transceiver transmits on the main band while transmits the DTMF set on the MENU46--Call Groups(CALL ID) if press this side key.
- » When SOS is programmed onto this key, the transceiver transmits on the main band and there is alarm prompt if press this side key.
- » When the B-PTT is programmed onto this key, the transceiver transmits on the sub band instead if press this side key.

Side key PF2 setting (PF2-DEF) ----- MENU56

There are long press and short press difference.

Short press, turn ON or OFF the FM radio function.

Long press(for 1 second), there are 5 options selectable, scanning, second, lamp, shift direction and keyboard light. Keyboard light is the default setting.

Side key PF3 setting (PF3-DEF) ----- MENU57

There are long press and short press difference.

Short press, Monitor key(MONI)

Long press(for 1 second), there are 4 options selectable, selective call, alarm, SOS and TX on the sub band(B-PTT). Alarm is the default setting.

Voltage Detect (VOLTAGE) ----- MENU58

It detects the voltage status.

Tone Scanning Detect (QT-SW) ----- MENU59

Check the detected tones are compatible when scanning.

Option: ON/ OFF

Default: OFF

Mute on the sub area (S-MUTE) ----- MENU60

Setting the volume status on the sub band when the transceiver is working on the main band.

Option: OFF/ RX mute/ TX mute/ RX and TX mute

Default: OFF

Reset setting (RESET) ----- MENU61

Feature Description: There are two options, functions reset and reset all. Function reset means all the menus setting will be reset to factory default. Reset all the channels, parameter and menus setting will be reset to factory default.

Default: Function reset

1. Memory Channel

- 1) When the transceiver works in the channel mode, it is able to copy all the parameters except the channel names into the specified channels.
- 2) When the transceiver works in the frequency mode, set the offset frequencies, shift direction and other parameter ahead, and then save into the specified channels.
- 3) Same frequency saved in one channel

For example, specified channel CH-10, same frequency 450.025MHz, RX CTCSS 67Hz, TX DCS DN023.

Step 1, input **4** WIN **5** TXP **0** 5 TXP **2** SAVE **5** TXP in the frequency mode

Step 2, press **MENU** + **1** BRT + **6** BFT6 + **MENU** to start setting RX CTCSS, use **▲** / **▼** to select 67.0, and then press **MENU** to confirm.

Step 3, press **MENU** + **1** BRT + **9** RO23 + **MENU** to start setting TX DCS, use **▲** / **▼** to select 67.0, and then press **MENU** to confirm.

Step 4, press **MENU** + **3** STEP + **0** + **MENU** to start selecting the desired channel CH-10 to memory.

Finally, press **0** + **1** BRT + **0**, and then **MENU** to confirm and finish.

If tone is not needed, then the step 2 and 3 are not necessary.

- 4) memory channel in different TX and RX frequencies. This is working for repeating communication.

For example, specified channel CH-10, RX frequency 450.025MHz with RX CTCSS 67.0Hz, TX frequency

Detailed Instructions of Some Important Functions

460.025MHz.

Step 1, input **4** **5** **0** **5** **2** **5** in the frequency mode.

Step 2, press **MENU** + **2** **8** to set the offset frequency 10.000MHz.

Step 3, press **MENU** + **4** **8** to set the side key be shift direction, and program the direction to "+".

Step 4, press **MENU** + **3** **0** + **MENU** to start selecting the desired channel CH-10 to memory.

NOTE

» Viewing the memory channel list, it means the channel is saved if the channel number displays blue while the channel is blank if the channel number displays red.

2. DTMF

(1) Manual Operation

This transceiver is independently supportable for the Call ID, Selective Calls and DTMF Decode. Setting the signaling type to DTMF is programmable via software ahead.

A. All Calls

Press PTT to transmit out the PTT ID of this transceiver, and then input "*" "+" "#" through the keypad to activate this function.

B. Group Calls

Press PTT to transmit out the PTT ID of this transceiver, and then input the group ID (the first ID digit) you want to call, "*" "+" "#" through the keypad to activate this function.

C. Selective Calls

Press PTT to transmit out the PTT ID of this transceiver, and then input the PTT-ID of the transceiver you want to call through the keypad to activate this function.

(2) Shortcut

It is programmable to set the PF1 or PF2 to be selective call, to automatically transmit out the message saved on the calling groups ahead.

A. Program the parameters for the groups via software. E.g., program 123456 as the PTT ID for group 1.

B. Program the calling group by number 01 on the MENU46.

C. Program the PF1 or PF3 to Selective Call Key on the MENU49 or MENU51.

D. Press the function key which has been programmed to Selective Call, then the transceiver will selectively call the transceiver with the PTT-ID 123456.

Please repeat the above steps, program the related settings for the group calls or the all calls on the different calling groups to get the shortcut.

Group calls

Detailed Instructions of Some Important Functions

Group number * + *

All calls * #

3. FM Radio

1) Activating FM Radio

In standby, press PF2 to activate the FM Radio function, while it shows the FM frequencies on the display.

2) Searching FM stations

Press # to enter into the FM menu, then press * to get it searching. When searching the correct station, it stops. Press ▲ / ▼ to change the searching direction.

3) FM Frequencies Editing

Press # to enter into the FM menu, and program the FM frequencies through the numeric keys within the FM range 76.02-108MHz.

4) FM Frequencies Memory

Press # to enter into the FM menu, switch to the sub menu "Save", press ▲ / ▼ to get the required group for memory, and then press MENU to confirm and save the FM frequency.

5) Invoking the saved FM frequencies

Press # to enter into the FM menu, switch to the sub menu "Call", press ▲ / ▼ to call out the saved

group, and then press MENU to confirm and save the FM frequency.

6) Exit from the FM Radio

Please press PF2 to exit out from the FM Radio mode. It is also OK to press PF2 from the menu list to exit.

NOTE

» When working on the FM frequencies, the current frequency and channel will be standby and it will be temporarily switched to two-way communication once getting the receiving signals, and then automatically get back to FM Radio after the signal disappears. Press PTT to transmit, and still gets back to FM Radio after 5 seconds.

4. Remote Control

1) Stun

Controlled code+ confirmed code CB+ controlled ID

Step 1, program the controlled code, controlled ID

E.g., controlled code is set to 126018 while the ID for the controlled transceiver is set to 898188.

Step 2, press PTT to transmit, then input 1 BRT 2 SAVE 6 PTT 0 1 BRT 8 SQL , ▼ (C) ▲ (B), 8 SQL 9 LOGS 8 SQL 1 BRT 8 SQL 8 SQL , the controlled transceiver will be stunned.

Detailed Instructions of Some Important Functions

- A. The stunned transceiver is only available for receiving, not transmitting.
- B. If the controlled code and ID are not 6 digit enough in step 2, add # .(e.g., the PTT-ID is 123, then add # after 123 input.)
- C. Repeat Step 2 to re-activate the stunned transceiver.

2) Kill

Controlled code+ confirmed code AB+ controlled ID

Step 1, program the controlled code, controlled ID

E.g., controlled code is set to 126018 while the ID for the controlled transceiver is set to 898188.

Step 2, press PTT to transmit, then input **1** **2** **6** **0** **1** **8** **8** , **EXIT** (A) **▲** (B), **8** **9** **8** **1** **8** **8** , the controlled transceiver will be killed.

- A. The killed transceiver is not available for receiving neither transmitting.
- B. If the controlled code and ID are not 6 digit enough in step 2, add # .(e.g., the PTT-ID is 123, then add # after 123 input.)
- C. Repeat Step 2 to re-activate the killed transceiver.

3) Monitor

Controlled code+ confirmed code DA+ controlled ID

Step 1, program the controlled code, controlled ID

E.g., controlled code is set to 126018 while the ID for the controlled transceiver is set to 898188.

Step 2, press PTT to transmit, then input **1** **2** **6** **0** **1** **8** **8** , **RPT** (D) (A), **EXIT** , the controlled transceiver will be monitored.

- A. If the controlled code and ID are not 6 digit enough in step 2, add # .(e.g., the PTT-ID is 123, then add # after 123 input.)
- B. There are only 15 seconds for monitor, and it ends if there are any operations on the monitored transceiver.

4) Inspection

Controlled code+ confirmed code DB+ controlled ID

The inspected transceivers will automatically transmit out their PTT-IDs like calling the roll. This feature is used to check whether the transceivers in groups are power on and within the available communication.

Step 1, program the controlled code, controlled ID

E.g., controlled code is set to 126018 while the ID for the controlled transceiver is set to 898188.

Step 2, press PTT to transmit, then input **1** **2** **6** **0** **1** **8** **8** , **RPT** (D) (B), **▲** , the controlled transceiver will automatically transmit out its PTT-ID after that.

- A. If the controlled code and ID are not 6 digit enough in step 2, add # .(e.g., the PTT-ID is 123, then add # after 123 input.)

Detailed Instructions of Some Important Functions

5. Non-standard CTCSS/DCS Setting

It is available to set the TX and RX non-standard tone separately, including the non-standard TX CTCSS, RX CTCSS, TX DCS and RX DCS.

The range for the non-standard CTCSS is 62-260MHz, while for the non-standard DCS is 000-777 (every digit of the tone should be lower than 7.)

Operations for non-standard RX/TX CTCSS

Step 1, press **MENU** to get to MENU16 "RX CTCSS" or MENU17 "TX CTCSS".

Step 2, input the non-standard CTCSS tone through the keypad, and press **MENU** to confirm while press **EXIT** to exit from the setting.

E.g., set the non-standard RX CTCSS to 67.4Hz.

Press **MENU** **1** **RT** **6** **SFT** **MENU** and **6** **SFT** **7** **VOX** **4** **WIN**, then press **MENU** to confirm while press **EXIT** to exit from the setting.

Operations for non-standard RX/TX DCS

Step 1, press **MENU** to get to MENU18 "RX DCS" or MENU19 "TX DCS".

Step 2, input the non-standard DCS tone through the keypad, and press **MENU** to confirm while press **EXIT** to exit from the setting.

E.g., set the non-standard RX DCS to D021N.

Press **MENU** **1** **RT** **8** **SOL** **MENU** and **0** **2** **SAVE** **1** **RT** (press **#** to set the negative code while it is not necessary.), then press **MENU** to confirm while press **EXIT** to exit from the setting.

Specification (CTCSS/DCS)

Appendix 1

CTCSS									
1	67.0	11	94.8	21	131.8	31	171.3	41	203.5
2	69.3	12	97.4	22	136.5	32	173.8	42	206.5
3	71.9	13	100.0	23	141.3	33	177.3	43	210.7
4	74.4	14	103.5	24	146.2	34	179.9	44	218.1
5	77.0	15	107.2	25	151.4	35	183.5	45	225.7
6	79.7	16	110.9	26	156.7	36	186.2	46	229.1
7	82.5	17	114.8	27	159.8	37	189.9	47	233.6
8	85.4	18	118.8	28	162.2	38	192.8	48	241.8
9	88.5	19	123.0	29	165.5	39	196.6	49	250.3
10	91.5	20	127.3	30	167.9	40	199.5	50	254.1

Appendix 2

DCS									
1	D023N	22	D131N	43	D251N	64	D371N	85	D532N
2	D025N	23	D132N	44	D252N	65	D411N	86	D546N
3	D026N	24	D134N	45	D255N	66	D412N	87	D565N
4	D031N	25	D143N	46	D261N	67	D413N	88	D606N
5	D032N	26	D145N	47	D263N	68	D423N	89	D612N
6	D036N	27	D152N	48	D265N	69	D431N	90	D624N
7	D043N	28	D155N	49	D266N	70	D432N	91	D627N
8	D047N	29	D156N	50	D271N	71	D445N	92	D631N
9	D051N	30	D162N	51	D274N	72	D446N	93	D632N
10	D053N	31	D165N	52	D306N	73	D452N	94	D645N
11	D054N	32	D172N	53	D311N	74	D454N	95	D654N
12	D065N	33	D174N	54	D315N	75	D455N	96	D662N
13	D071N	34	D205N	55	D325N	76	D462N	97	D664N
14	D072N	35	D212N	56	D331N	77	D464N	98	D703N
15	D073N	36	D223N	57	D332N	78	D465N	99	D712N
16	D074N	37	D225N	58	D343N	79	D466N	100	D723N
17	D114N	38	D226N	59	D346N	80	D503N	101	D731N
18	D115N	39	D243N	60	D351N	81	D506N	102	D732N
19	D116N	40	D244N	61	D356N	82	D516N	103	D734N
20	D122N	41	D245N	62	D364N	83	D523N	104	D743N
21	D125N	42	D246N	63	D365N	84	D526N	105	D754N

Please double check the transceiver according to the trouble shooting in the following table before recognizing the transceiver as the fault. And please rest the whole transceiver if the following problems happen often in order to correct the improper operations.

PROBLEM	SOLUTION
Cannot be powered on.	<ul style="list-style-type: none"> » Please change a new battery or re-change as the battery may be out of change. » Please take out the battery and re-install as the battery may be installed incorrectly.
The time for battery working is not so long as usual.	<ul style="list-style-type: none"> » Please change a new battery as the battery life is over. » Make sure the battery is fully charged before taking it out of the charger.
The indicator on the transceiver keeps flashing green, but there is no audio heard.	<ul style="list-style-type: none"> » Make sure the volume is clear enough for communication. » Check whether the programmed CTCSS or DCS is compatible during the communication. » Make sure the mute mode is correct setting.

Trouble Shooting

PROBLEM	SOLUTION
The keypad is useless.	<ul style="list-style-type: none"> » Check whether the keypad is programmed to keylock. » Check whether there are any keys stuck.
The transceiver automatically transmit even there is no press on PTT.	<ul style="list-style-type: none"> » Check whether VOX is on, and the level is too low.
Some functions are not able to be programmed.	<ul style="list-style-type: none"> » Check whether the transceiver works in the channel mode as some functions should be programmable via software.
There is other audio interrupted when communication.	<ul style="list-style-type: none"> » Change the CTCSS or DCS.

Optional Accessories

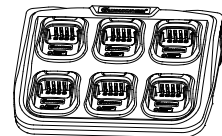

Six way charger

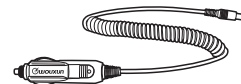

Car Charger

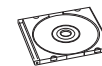

Programming Software

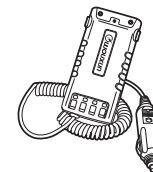

Eliminator

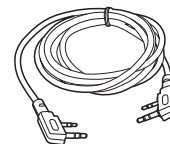

Wire-clone cable



Headset



MIC/Speaker



(SL16) (BNC)

Antenna Adapter

Announcement

We are working hardest to make the manual perfect, but there is still emission and printing errors. All the above specification is subject to updated by  without prior notice.

English Version:1601-V2

DECLARATION OF CONFORMITY

We, Quanzhou Wouxun Electronics Co.,Ltd,
No.928 Nanhuan Road,Jiangnan High Technology Industry Park,Quanzhou,
Fujian 362000,China,

declare that our product:

Product Description: Two-way Radio
Brand: WOUXUN
Model: KG-UV9D(P1us)

is in compliance with the essential requirements and other relevant provisions of the R&TTE directive 1999/5/EC and carries the CE mark accordingly.

Supplementary information:

The product complies with the requirements of:

Low Voltage Directive 2006/95/EC
-EN 60950-1 +A11+A1+A12

Efficient use of frequency spectrum
-EN 301 783-1
-EN 301 783-2

EMC Directive 2004/108/EC
-EN 301 489-1
-EN 301 489-5

EMF
-EN 62311: 2008

Date: March 16, 2014

Place: Quanzhou,Fujian,China

Name: Danny Chen

Signature: 

Quanzhou Wouxun Electronics Co.,Ltd.
Add:No.928 Nanhuan Road,Jiangnan High Technology Industry
Park,Quanzhou,Fujian 362000,China
Tel:+86 595 28051265 Fax:+86 595 28051267

Http://www.wouxun.com

MEMO

MEMO
